

The Contest JUG



NEWSLETTER OF THE
NORTHERN CALIFORNIA CONTEST CLUB
44 Toyon Terrace
Danville, CA 94526

May 1985

No. 156

PRESIDENT:	K6GSS	VP/CC:	WB6FCR	PROGRAMS:	WB6KBZ
SEC/TREAS:	K6ZM	FINANCE:	WA6AUE	AWARDS:	KA6ING
JUG EDITOR:	W6SZN	DIRECTORS:	W6RGG, WB6KBZ,	MEMBERSHIP:	WB6FCR
JUG POST PROD:	K6HNZ		AJ6V, WA6AUE		

NO MAY MEETING

COMING EVENTS

May

25-26 CQ WPX CW
27 No Club Meeting

June

6 BOD at W6RGG, 7:30 p.m.
8-9 ARRL VHF QSO Party
22-23 ARRL Field Day
24 Membership Meeting, CWA Hall, 7:30 p.m.

FROM THE PRES

Thanks to Ed Radlo, AJ6V, for a job well done last year. We certainly reaffirmed our supremacy in ARRL SS and the WPX looks good at this point. Thanks to all who participated.

One of the things I have finally learned is that the only constant in life is change, and over the years our club and each member has changed. Our work habits, life styles, and operating habits have all changed. Some observations: fewer members at the CWA Hall meetings, more YL's at dinner meetings, new members operating just about every contest on the calendar, and of course, some of our longer term members not operating at all. There isn't anything necessarily wrong with any of this, but we are today a contest club with a shrinking membership. I would like to reverse this trend.

In past years, our contesting activity has centered around fall contests, starting with the California QSO Party (CQP) and ending with CQWW or ARRL SS. To make us a more

THE CONTEST JUG May 1985 No. 156

"year around club," we will be participating as a club in the 1985 CQWW and the 1986 WPX. The CQP, sponsored by NCCC, is a good warm-up, and should get some friendly competition going. At the May BOD meeting, contest recognition was discussed, and you will be hearing more about incentives to KB in the future.

I mentioned change earlier and along that line is the subject of club meetings. Our CWA attendance is down, our banquet attendance is up (although we don't launch a Clipperton Expedition every month). We are going to alternate meeting styles, basically every other month at the CWA, with the programs aimed at improving our operating methods, our station effectiveness and our contest scores (you guys who forgot more than us new-comers know, QNE). Every other meeting will be more social, with food, YL's, XYL's, and a program that should interest our non-amateur friends as well as ourselves. Tentative plans include a dinner meeting on July 19 in the East Bay (keep your fingers crossed), and a picnic in August.

Among my recent activities was the West Coast VHF-UHF Conference. George, WB6GBZ and I did a recap of the June 1984 ARRL VHF contest. Our 106k score and #8 national score brought up some interesting points in VHF contesting. Our audience included W3XO, Editor of The World Above 50 MC. Bill was impressed with our innovative tricks (post cards do work -- thank you, Gary) and Bill told me afterwards, "I now have a better understanding of VHF contesting in the West."

One of the major interests of VHF conferences is antenna gain measuring, and this year was no exception. Elsewhere in The Jug is a steerable (at least 4 directions) antenna that, for 80 meters, still fits on a city lot, has 3.4 DB forward gain over a dipole and a 10 DB front to back ratio. The two meter model had some anomalies due to construction, but if someone can erect one for 40 or 80 before I get mine up, I would appreciate hearing about it. (Or maybe this old modified W6SAI design can be beat?)

If you know of some simple tricks that worked for enhancing your contest score or DXability, and would like to share them, please pass them along to me.

73,

John

* * * *

June 8, 1985

Look For VHF Contesters

147.540 FM

12 pm, 3 pm, 6 pm

They Need Your QSO!

* * * *

FROM THE VP/CC

As the new VP and contest chairperson, it's my task to drum up enthusiasm for the major contests in which the club will participate -- CQWW, CQP, AND WPX. It's never too early to plan for a contest! The NCCC is not just a launching pad for DXpeditions -- the club exists for all members to contribute the best they can and to have fun. So, I will be contacting every member to encourage them to get on and help the club's effort in the contests. There is no such thing as a low score, as far as the NCCC is concerned.

73,

Al Crespo, WB6FCR

BOD MEETING MINUTES

Board of Directors meeting, 15th of May, 1985, at the home of K6GSS. Attended by K6GSS, WB6FCR, W6RGG, WB6KBZ, KN6K, K6ZM.

Treasury reports were not given. KN6K said he would turn over all treasurer's accounts to the incoming secretary/treasurer K6ZM within two weeks.

Old Business: On the agenda was the legality of international honorary membership. After discussion, the issue was tabled. The member reinstatement issue has not been reported on as yet by the Committee of K6HNZ, K6TMB and W6SZN but a report is expected very soon. The new roster is needed very badly and K6GSS will attempt to expedite its publication and distribution. K6ZM will look for a new badge supplier who can handle small quantity orders. It was decided to make no changes in our logo or badges.

New Business: The Board of Directors agreed to hold their meetings on the first Thursday of each month, except in July which will be on the second Thursday, the 11th. The next BOD meeting will be June 6 at 7:30 p.m. at the home of W6RGG in Castro Valley. There will be no membership meeting on May 27 because of the Memorial Day holiday. The regular June meeting will be on June 24 at the CWA Union Building on Mission Street in Hayward at 7:30 p.m. A dinner meeting is being planned for Friday night, July 19 at Miguel's in Hayward with the hopes of a first showing of Clipperton video tapes. All Northern California DX Club members are cordially invited. The picnic with no date set as yet is on the menu for the August meeting.

New appointments: WB6FCR will be membership chairman. WB6KBZ will be program chairman. WA6AUE will continue as finance chairman and KA6ING will continue as awards chairman. Other appointments will be made when required.

Next year's budget will be presented for approval at the June meeting.

During the coming year, emphasis will be on the CQP contest, handled by K6XO, and the CQWW and CQWPX managed by WB6FCR.

-- K6ZM

CONTESTERS TAKE NOTE

"In another matter, that of station identification, FCC agreed with a petition filed by Dave Popkin, W2CC, that an order of last January 25 was confusing and almost completely precluded the transmission of any callsign other than one's own. Section 97.121 False Signals is modified as follows.

An amateur radio station must not transmit:

- (a) False or deceptive signals or communications by radio; NOR;
- (b) For purposes of identifying the station, any call sign which has not been assigned to it. Notwithstanding the foregoing, when a station is operated within the privileges of the operator's class of license but which exceed those of the station licensee, station identification must be made by following the station call sign of the station being operated with the operator's primary station call sign in accordance with Section 97.84(b).

COMMENT

Last January, TDXB noted that the new rule still did not make clear whether it was legal to use your own callsign from another station. This is a matter which is of prime importance to contest operators and others who do not have a station of their own. Although each FCC license does specify a "fixed station location," you can move to another (unlicensed) location and use your assigned callsign while your FCC license is being modified.

However, if you operate from another station which is owned by an FCC licensee, and that location is specified as that licensee's "fixed station location," then clearly it is illegal to use your own callsign.

Unfortunately, this is going too far. The intent of the rule is to make it illegal for someone to use another's callsign without authorization. This is not likely to prevent 'bootlegging,' or pirating of callsigns.

What this new rule will make illegal is what we think is a perfectly legitimate activity . . . one licensee sitting down at another licensee's station and, with the station licensee's permission, using one's own callsign instead of the assigned station callsign."

INVERTED "V" BEAM

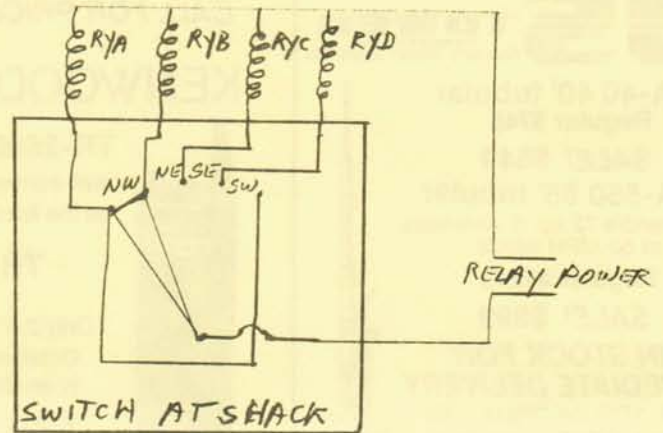
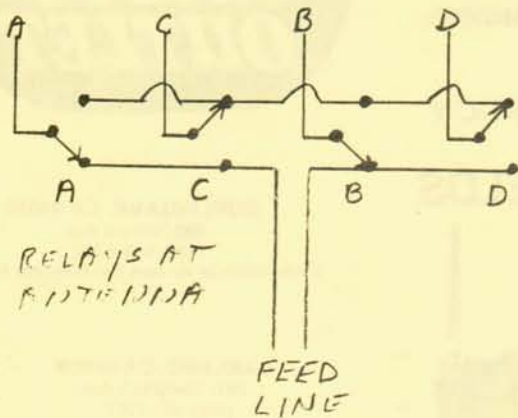
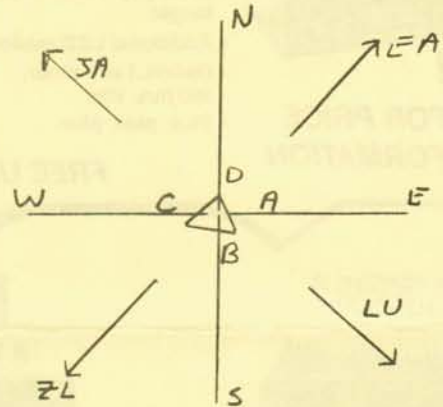
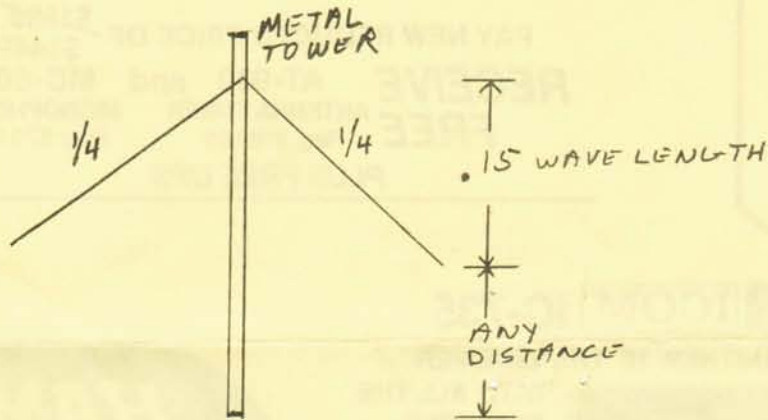

This is an inverted V with a resonant director, using a single support and yielding over 3 db gain over a dipole. (3.4db at West Coast VHF Conf. and 5db on my range at home) The radiation is horizontal, rather than vertical like slopers, and the pattern has some deep nulls. (good-bye, QRM) Other than two inverted "V's", materials include 4 spdt relays, some 5 conductor cable and a 4 position shorting switch. Some experiment was done at 2 meters to determine the effect of height to gain and pattern and it appears that as the inverted Vees were made steeper, the gain started dropping off, probably due to the now more vertical components cancelling one-another. A distance of 0.15 wavelength appears to be about optimum for height difference from the top of the Vee to the bottom of the Vee. Now, if I could just turn the City about 45 degrees, Hi. I am interested in other simple "city lot" antennas, and would like to hear about your successes. 73's, John.

NEW! KENWOOD TS-940S

TOP-OF-THE-LINE HF TRANSCEIVER



- General coverage receiver.
- 40 memories.
- 250W pep. Runs cooler, longer.
- Additional LCD readout.
- Option...l ant. tuner, 160 thru 10M.
- Plus, plus, plus.

NEW!

CALL FOR PRICE AND INFORMATION

FREE UPS

KENWOOD

TS-930S

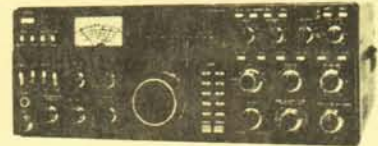

PAY NEW REDUCED PRICE OF ~~\$1599~~ \$1449

RECEIVE AT-930 and MC-60A
FREE ANTENNA TUNER MICROPHONE
Reg. \$199.95 Reg. \$79.95

PLUS FREE UPS

YAESU

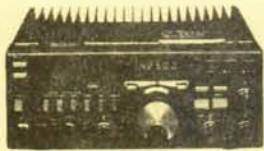

FT-757GX

ICOM IC-735

A BRAND NEW HF TRANSCEIVER

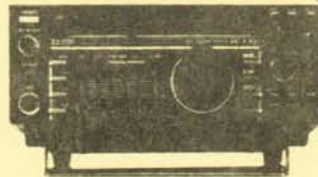

WITH ALL THE FEATURES THAT MAKE IT A TRULY OUTSTANDING BUY!

CALL FOR PRICE AND INFORMATION



KENWOOD HAND-HELDS



TR-2600A Deserves its well-earned reputation as the leading HT

TH-21AT/41AT
COMPACT!

Only 2.4"W, 4.72"H, 1.1"D
Outstanding performers in an ideal package size.

CALL FOR PRICE



BURLINGAME, CA 94010

999 Howard Ave.
(415) 342-5757.

5 miles south on 101 from San Francisco Airport.

OAKLAND, CA 94609

2811 Telegraph Ave.,
(415) 451-5757.

Highway 24 Downtown. Left 27th off-ramp.

US TOWER CORPORATION

Formerly Tristao Tower Co.

MA-40 40' tubular
Regular \$745

SALE! \$549

MA-550 55' tubular

Will handle 12 sq. ft. antennas at 50 MPH winds.

Regular \$1245

SALE! \$899

IN STOCK FOR

IMMEDIATE DELIVERY

CALL FOR INFORMATION ON ALL OTHER MODELS



THE CONTEST JUG—Published Monthly By
THE NORTHERN CALIFORNIA CONTEST CLUB
44 Toyon Terrace
Danville, CA 94526



FIRST CLASS
FIRST CLASS
FIRST CLASS

W6OAT
EPPS, CHARLES K
948-H KIELY BLVD
SANTA CLARA, CA 95051

EXPIRES:0685